

# **SKTESS72/86/100**

## **Industrial and commercial Energy Storage System CABINET BATTERY**



**User Manual V2.0**

# Table of Contents

<b>Statement</b> .....	<b>1</b>
<b>Copyright</b> .....	<b>1</b>
<b>Notice</b> .....	<b>1</b>
<b>Revision History</b> .....	<b>1</b>
<b>Preface</b> .....	<b>2</b>
<b>Overview</b> .....	<b>2</b>
<b>Model description</b> .....	<b>2</b>
<b>Target Audience</b> .....	<b>2</b>
<b>Symbol Conventions</b> .....	<b>2</b>
<b>1 Safety Information</b> .....	<b>3</b>
1.1 General Safety .....	3
1.2 Personal Safety .....	4
1.3 Electrical Safety .....	5
<b>2 Product Description</b> .....	<b>7</b>
2.1 System Description .....	7
2.2 Product Introduction .....	8
2.3 System Appearance .....	8
2.4 Part Description .....	9
2.5 Main Modules .....	10
2.6 Operating Principle .....	14
2.7 Work States .....	14
2.8 Symbols .....	15
<b>3 Transportation and Storage</b> .....	<b>16</b>
3.1 Transportation Requirements .....	16
3.2 Storage Requirements .....	17
<b>4 Preparation before Installation</b> .....	<b>19</b>
4.1 Installation Site Selection .....	19
4.2 Tools Requirement .....	19
4.3 Additionally Required Materials .....	20

- 5 Installation ..... 21**
  - 5.1 General ..... 21
  - 5.2 Clearance Requirement ..... 22
  - 5.3 Mechanical Installation ..... 22
  - 5.4 Electrical Connection ..... 23
- 6 System Commissioning ..... 24**
  - 6.1 Check before Power On ..... 24
- 7 Troubleshooting and Maintenance ..... 25**
  - 7.1 Troubleshooting ..... 25
  - 7.2 Maintenance ..... 26
- 8 Technical Data ..... 29**
- A Crimping DT or OT Terminals ..... 30**
  - A.1 Terminal Requirements ..... 30**
  - A.2 Crimping an OT or DT Terminal ..... 31**
- B How to Repaint the Cabinet ..... 32**
  - B.1 Light Scratches and Small Areas of Stubborn Stains ..... 32
- Repainting Procedure ..... 33**
  - B.2 Deep Scratches and Large Areas of Stubborn Stains ..... 34
- Repainting Procedure ..... 34**

## Statement

### Copyright

Copyright © Sunket. All rights reserved.

### Notice

The purchased products, services, or features are subject to the contract, and all or part of that described in this document may not be within the scope of your purchase or use. Except as otherwise agreed in the contract, we make no representations or warranties of any kind, express or implied, regarding the content of this document.

This document may be updated without notice. Unless otherwise agreed, this document is intended as a guidance only, and all statements, information, and recommendations in this document do not constitute any express or implied warranty.

### Revision History

The revision history summarizes descriptions of each document update. The latest issue of the document contains all changes made in previous issues.

#### **Version 1.0 (2025-08-31)**

Initial release.

#### **Version 2.0 (2025-12-05)**

Add SKTESS72/86

## Preface

### Overview

This document describes how to install, connect, commission, and troubleshoot SKTESS72/86/100 cabinet battery. Please read this manual carefully to get familiar with the safety instructions and functions, and features of cabinet battery before installing and using the energy storage system.

### Model description



No.	Definition	Description
1	Product name	SKTESS:Battery energy storage system produced by Sunket
2	Battery energy	72/86/100:Indicate that the battery Rated energy is 72/86/100kWh

### Target Audience

This manual is intended for operators and engineers in power plants.

### Symbol Conventions

In this document, the following symbols that may exist herein mean as below.

Symbol	Description
<b>Danger!</b>	A high-risk hazardous situation which, if not avoided, will result in death or serious injury.
<b>Warning!</b>	A medium-risk hazardous situation which, if not avoided, could result in death or serious injury.
<b>Caution!</b>	A low-risk hazardous situation which, if not avoided, could result in minor or moderate injury.
<b>Notice!</b>	Provides tips for the optimal operation of the product.

# 1 Safety Information

## 1.1 General Safety

Before transporting, storing, installing, operating, using and/or maintaining the device, please carefully read and understand this document, and strictly follow the instructions and safety precautions given herein, as well as symbols affixed on the device. The safety instructions herein are only supplements to local laws and regulations.

The operator should not only abide by all safety precautions provided in the document, including but not limited to the 'Danger!', 'Warning!', 'Caution!', and 'Notice!' signs, but also comply with relevant international, national and local laws, regulations, standards, guidelines and industry rules in the process of transportation, storage, installation, operation, and maintenance. We will not assume any responsibilities for the loss caused by improper operation, or violation of safety standards for design, production and equipment suitability.

We will not be liable for maintenance for possible device failure, device malfunction, or parts damage, nor will the company assume any liability to pay compensation for the possible physical and property damage resulting from the installation environment that does not meet the design requirements.

The device is well designed and tested to meet all applicable state and international safety standards. However, like all electrical and electronic equipment, safety precautions must be observed and followed during the installation of the device to reduce the risk of personal injury and to ensure a safe installation.

We will not assume any responsibilities if any of the following circumstances occur, including but not limited to:

- Device damage due to force majeure, such as earthquake, flooding, thunderstorm, lightning, fire hazard, volcanic eruption, war, typhoon, tornado, etc.

- Device damage due to human cause.

- Device used or operated against local policy or regulations.

- Failure to follow the operation instructions and safety precautions on the product and in this document.

- Installation and use under improper environment or electrical condition.

- Unauthorized modifications to the product or software.

- Device damage caused during transportation by the customer or the third party.

- Storage conditions that do not meet the requirements specified in this document.

- Use of incompatible devices.

- Installation and commissioning operated by unauthorized personnel who are not licensed and /or satisfy state and local jurisdiction regulations.

## 1.2 Personal Safety

Only qualified personnel can operate the equipment, including transportation, transfer, installation, cable connection, and maintenance. Wear personal protective equipment that meets local safety protection requirements while operating the equipment.

Operators must receive the relevant training and pass the examinations of the Company and have professional knowledge of the energy storage system.

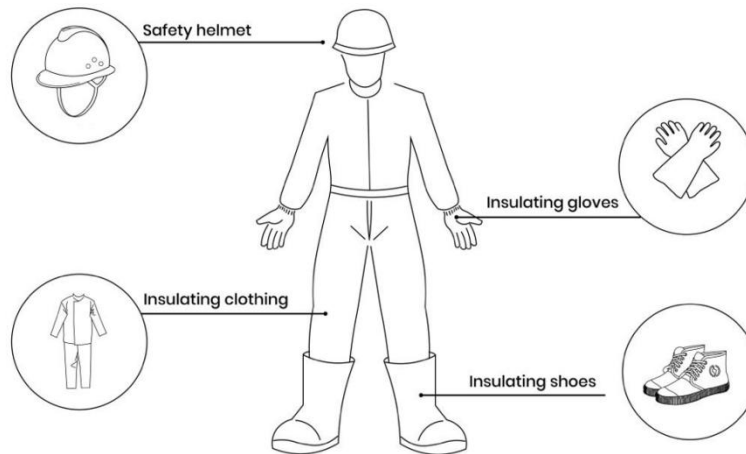

Figure 1-1 Wearing method of PPE

For qualification requirements, refer to your local laws and regulations and industrial standards.

Do not wear conductive objects such as watches, bracelets, rings, and necklaces during installation, operation, and maintenance to avoid burn injury due to electric shock.

Transport, transfer, install, connect, and maintain the system in strict accordance with the laws, regulations, and related standards of your country or region.

Keep familiar with the compositions and working principles of the energy storage system and operate the equipment according to the User Manual.

### 1.3 Electrical Safety

#### Danger!

- Please make sure that the unit is free from any damage before the electrical connection.
- Do not modify, change, or dismantle the device, do not change the power-on and power-off sequences and the installation procedure written in the document, and please properly and correctly operate it.
- Do not power on the device during installation. Otherwise, it may cause a fire, personal injury, or device damage.
- Must remove earrings, rings, bracelets, watches, and any other metal jewelry before operation, to avoid electrical shock, burns, or even death.
- During operation, special insulated tools must be used to avoid electric shock or short circuit failure. The insulated tools' voltage ratings must exceed the system voltage ratings.

#### Warning!

- Please wear PPE, such as, protective clothing, insulating shoes, goggles, safety helmets, insulating gloves, etc., when conducting electrical wiring.
- Do not touch the power supply equipment directly, or through conductors or damp objects.
- Do not touch the parts of the equipment of which warning signs are attached, to avoid personal injury or device damage.

#### Caution!

- Do not power on the device until it has been installed and confirmed by professionals.
- In the event of a fire, evacuate immediately and call the local fire services.

#### Notice!

- Please operate according to the safety code for power station.
  - Before installation, it is necessary to set up temporary safety fences or warning lines and hang warning signs in the operation area, to prohibit non-staff from entering here.
  - Please make sure that the equipment and its associated switches are off before connecting and disconnecting power cables.
- Please check whether the protective housing and insulating sleeve for an electrical component have been installed correctly after finishing installation, to avoid electric shock.
- Must turn off the output switch of the power supply equipment when maintaining its electrical terminal device and power distribution device.
  - If the device is required to be powered off during troubleshooting and diagnosis, please do as the following procedure: power off > electricity testing > connecting grounding cable > hanging warning signs and setting up guardrails.
  - Must hang up “Do Not Switch On” warning signs on the relevant switches or circuit breakers before completing maintenance, to prevent power connection. Do not switch on before the fault is

solved.

- Do not use water, alcohol, oil, or other solvents when cleaning electrical components inside and outside the device.

**Grounding Requirements:**

- The device's grounding impedance shall meet the requirements of local electrical safety standards.
- The equipment shall be permanently connected to a grounding wire within the building's electrical system. Please check whether the device is reliably grounded before operation. The grounding cable should be removed last while dismantling and maintaining the device.
- Do not start the device if it is not fitted with a grounding conductor.
- All acts against the grounding conductor are prohibited.
- If the device is equipped with a three-pronged socket, make sure that the ground prong is reliably grounded.
- For the device that may generate large contact currents, please make sure that the grounding terminal on the housing has been grounded before powering on, to avoid electric shock.

**Cable Requirements:**

- When deciding the wire diameter, and connecting or wiring cables, follow the local laws, regulations, and codes to ensure safety.
  - When external conditions (e.g., placement method, ambient temperature, etc.) change, the cable type must be verified according to IEC-60364-5-52 or local laws, regulations and standards.
  - Before connecting power cables, please make sure that the cable labels are correctly labelled and the cable terminals are well insulated.
  - Do not loop and twist cables while conducting electrical wiring. If the length of the power cable is not enough, please replace it instead of joining or welding. Ensure that all the cables of the correct type and size are fully connected and well insulated, and the edges of cable slots and crossing holes are smooth.
- Please use fireproof mud to seal the threading openings immediately after finishing wiring, to avoid the entry of water vapor or small animals.
- Cables should be kept away from heaters or other heat sources, because a high temperature environment may result in aging and damage to cable insulation.

## 2 Product Description

### 2.1 System Description

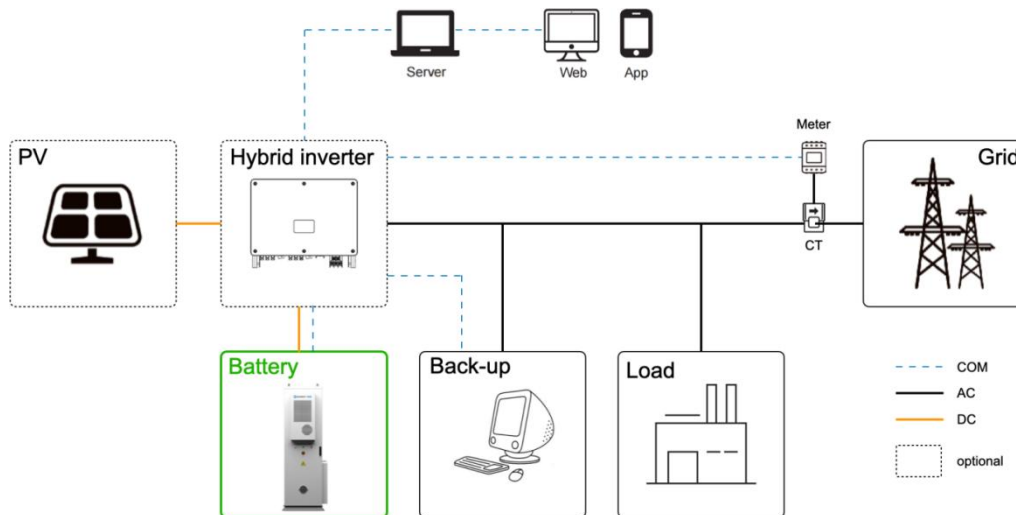

Figure 2-1 System overview diagram

Table 2-1 System item description

Item	Description
Battery	SKTESS72/86/100 is an intelligent outdoor battery cabinet.
Meter/CT	The meter/CT is used for import / export or consumption readings, and manages the battery charge / discharge accordingly for smart energy management applications.
Hybrid inverter	In off-grid or grid-connected systems, hybrid inverters can intelligently distribute power sources, prioritizing the use of solar power generation, battery energy storage, or grid electricity to improve energy utilization efficiency and reduce electricity costs.
Grid	400 V / 230 V and 380 V / 220 V grid are supported.
PV (optional)	Add DCDC modules, converts the direct current (DC) generated by solar panels into alternating current (AC), or boost PV strings for battery charge.
Server	It is an intelligent, multifunctional monitoring platform that can be accessed either remotely or through a hard-wired connection. With the Intelligent Energy Storage Cloud Platform, the operators and installers can always view key and up-to-date data.

## 2.2 Product Introduction

The SKTESS100 air-cooled industrial and commercial energy storage DC cabinet adopts a modular design, integrating core components such as lithium iron phosphate batteries, battery management systems, fire suppression systems, pressure relief and explosion-proof devices, and temperature control systems into a standard cabinet. This product supports communication protocols of mainstream Hybrid grid inverter/EMS equipment in the market and is equipped with abundant interfaces. By integrating an external hybrid grid inverter, it can support both DC and AC inputs simultaneously, achieving stable power supply for grid-connected power supply and electrical equipment. It is suitable for various scenarios such as industrial and commercial applications, household electricity use, and microgrids. Multiple devices can be directly paralleled to expand the energy storage system, featuring plug-and-play functionality and flexible power usage modes.

## 2.3 System Appearance

Dimension(W\*D\*H): 851.5(±5)×1325(±5)×2280(±5)mm(Rings not included)

Net weight:

SKTESS72	SKTESS86	SKTESS100
1050±10kg	1150±10kg	1250±10kg

Product IP grade: IP54

Anti-corrosion level: C3

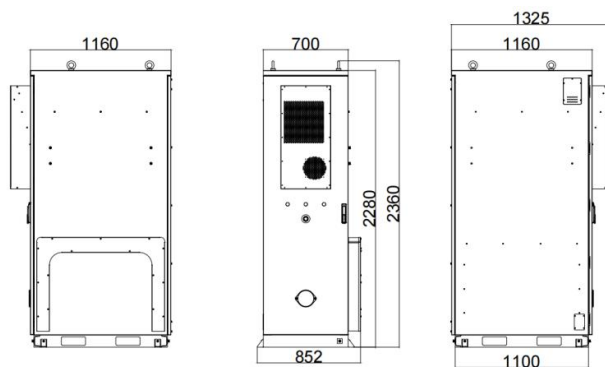

Figure 2-2 Appearance and dimensions

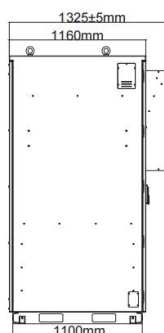

Figure 2-3 Fork position dimensions

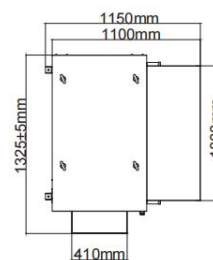

Figure 2-4 Angle supports position dimensions

## 2.4 Part Description

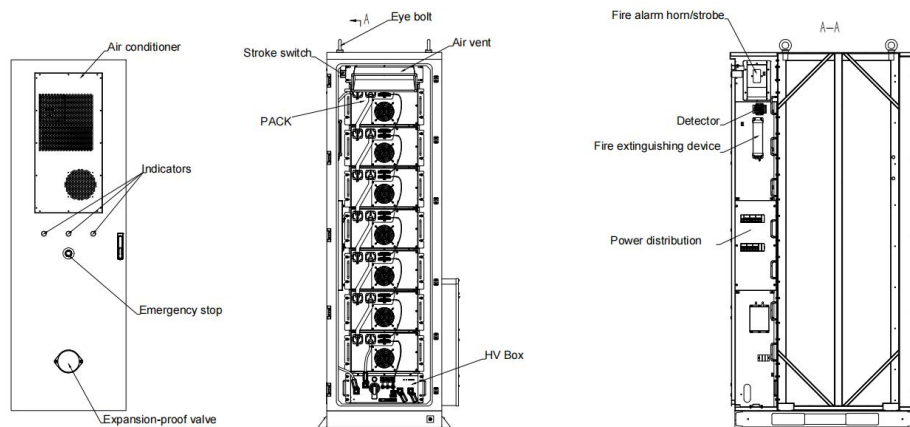

Figure 2-5 Parts description (in the closed state)

Table 2-2 Parts description

No.	Item	Qty	Description
1	Air conditioner	1	Energy storage system air conditioner.
2	Indicators	1	<p>FAULT Light : The fault indicator light of the device is on when the light is on in the device or system, indicating that there is a fault or abnormal situation.</p> <p>RUN Light: The indicator light of the equipment running status is on when the light is on, indicating that the equipment is running or the system is activated.</p> <p>POWER Light: The indicator light of the device power supply status will light up when the device is powered on or running, indicating that the device is in operation.</p>
3	Emergency stop	1	To shut down the system in emergency circumstances.
4	Expansion-proof valve	1	To exhaust the combustible gas out of the cabinet.
5	Eye bolt	4	Material lifting applications.
6	Stroke switch	1	Check whether the cabinet battery door is closed,Lighting when door opened.
7	Air vent	1	To transport air from HVAC , Used to regulate the temperature inside the vehicle and the airflow.
8	PACK	5/6/7	Battery pack.
9	Rain shield	1	To restrain rain or snow.
10	HV Box	1	Control the charge and discharge of packs.
11	Fire alarm horn/strobe	1	Generates alarms for internal devices when abnormal temperature or smoke occurs.
12	Detector	1	To detect smoke, temperature, CO, VOC.
13	Fire extinguishing device	2	To control or suppress the spread of fire.
14	Power distribution	1	To distribute AC power for the energy storage system.

## 2.5 Main Modules

### 2.5.1 Battery Pack

The Battery Pack adopts 280Ah LFP battery, which have excellent safety, high energy density;

The Battery Pack Configuration : 1P16S; Capacity: 14.33kWh /Pack;

The Battery Pack adopts air-forced cooling method by fan;

The Battery Pack is equipped with IP20 grade, pollution-free modular assembly, high structural reliability and low maintenance cost.

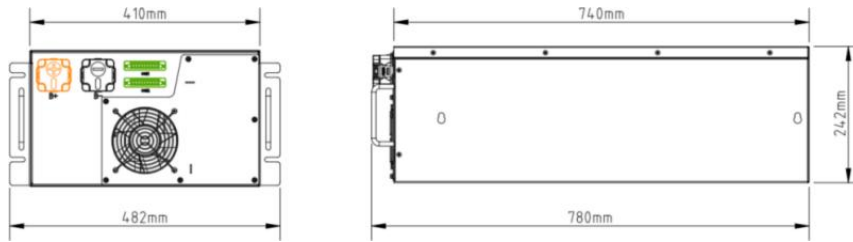

Figure 2-6 Battery Pack appearance and dimensions

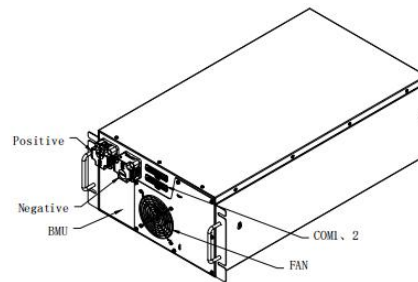

Figure 2-7 Part description

Table 2-3 Part description

No.	Item	Description
1	Positive	To connect positive terminal of high-voltage box or battery pack.
2	Negative	To connect negative terminal of high-voltage box or battery pack.
3	BMU	Battery Management Unit,Collect battery information and control battery charging and discharging.
4	COM1、 2	To connect communication cable.
5	FAN	To keep components cooling in the enclosure.

Table 2-4 Technical Specification

Item	Technical Specification
Cell capacity	280Ah
Cell material	Lithium iron phosphate (LFP)
Pack Configuration	16S
Rated voltage	51.2V
Operating voltage range	44.8~57.6V
Nominal energy	14.336kWh
Charge and discharge rate	<0.5C
Cooling mode	Forced air cooling
Balancing mode	Passive cell balancing
Dimensions (H x W x D)	(242±5) x (482±5) x (780±5)mm
Weight	<110±2kg

### 2.5.2 High-voltage Box

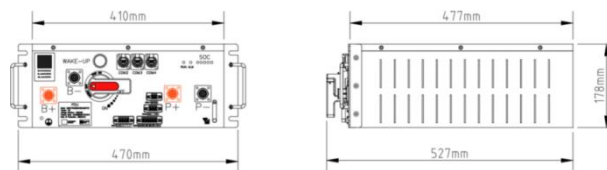

Figure 2-8 High-voltage box dimensions

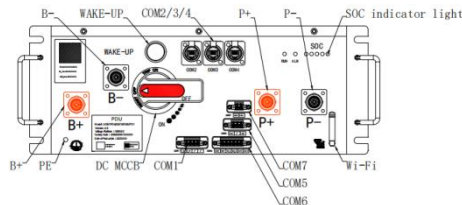

Figure 2-9 Part description

Table 2-5 Description of front panel

Item	Description
PE	Ground connection point.
B+	To connect battery pack's positive terminal.
B-	To connect battery pack's negative terminal.
DC MCCB	A switch for DC side.
COM1	To connect DC/DC power supply for fan.
COM5	To connect fan.
COM6	HV box output port.
COM7	To connect BMU.

DC MCCB	A switch for DC side.
Wi-Fi	To connect internet.
SOC	To show statue of rack.
P+	To connect PCS's positive terminal.
P-	To connect PCS's negative terminal.
COM2/3/4	Communication port.
Power	To display the power status of BMS.

Table 2-6 Technical Specification

Item	Technical Specification
Rated voltage	1000V
Rated current	250A
IP rating	IP20

### 2.5.3 Air conditioner

The enclosures that contain battery energy storage systems are often located outdoors and exposed to extreme temperatures. And the batteries generate heat when charged and discharged, so active cooling and heating should be introduced to cabinet battery enclosures to maintain an ideal temperature range.

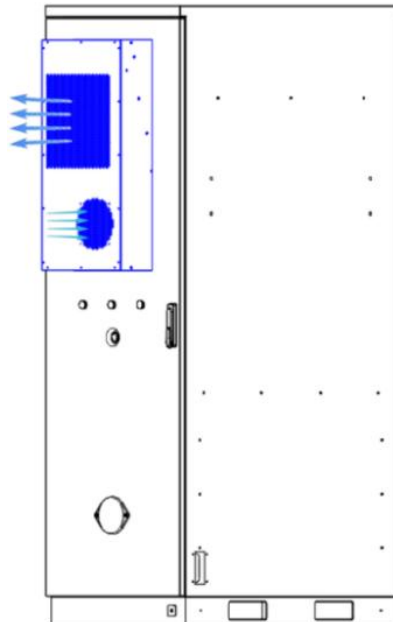

Figure 2-10 Air conditioner appearance

Table 2-7 Technical Specification

Item	Technical Specification
Power specifications	AC 220V±10%, 50Hz
Cooling capacity	1500W
Heating capacity	1000W
Rated cooling power	850W
Rated heating power	1250W
Air flow volume	445m <sup>3</sup> /h
Refrigerant	R134a
Heating operating temperature	-20~50°C
Cooling operating temperature	-10~50°C
IP rating	IP55
Dimensions (H x W x D)	450 x 240 x 890mm
Weight	35kg

#### 2.5.4 Fire extinguishing device

Aerosol fire extinguishing device adopts temperature-triggered startup mode. The combustion of the heat-sensitive wire activates the aerosol generating agent in the device. The heat released by the redox reaction of the agent decomposes the chemical coolant, enable the agent and the coolant to participate in fire extinguishing.

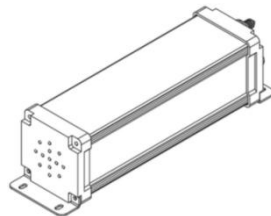

Figure 2-11 Fire extinguishing device appearance

#### 2.5.5 Detector

The detector integrates smoke, temperature, CO, and VOC measurement parameters in a highly integrated manner. It has a wide range of applications and can comprehensively detect and analyze the thermal runaway characteristics of lithium batteries.



Figure 2-12 Detector appearance

## 2.5.6 Expansion-proof valve

Pressure-activated venting system which can automatically releases internal gas/smoke upon detecting overpressure or smoke, preventing explosions in energy storage enclosures.

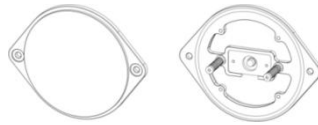

Figure 2-13 Valve appearance

## 2.6 Operating Principle

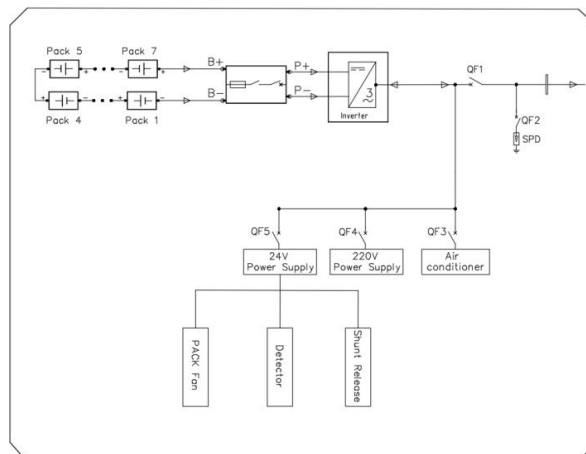

Figure 2-14 Electrical Block Diagram

### Notice!

•In an off-grid situation, the current will vary due to the types of electrical loads. The common electrical load can be classified into following types, resistive load, inductive load, capacitive load, half-wave load, etc. Therefore, the types of electrical loads shall be fully considered when designing and configuring a system. In the case of an uncertain electrical load, please contact the supplier for evaluation of output supply to special loads.

## 2.7 Work States















There are four states for the energy storage system including running, shutdown, fault, standby.

Table 2-8 Five States

State	Description
Running	The energy storage system stores external direct current into battery or discharges electric energy to outside units.
Shutdown	The energy storage system stops charging and discharging and powers off battery packs.
Fault	The equipment is faulty when a fault is detected.
Standby	The equipment is in standby mode.

## 2.8 Symbols

Table 2-9 Symbol description

Symbol	Description
	CE mark of conformity.
	Protective grounding point.
	Grounding point.
	Caution, hot surface. The enclosure temperature may be high while running. Therefore, do not contact to avoid scalding.
	Danger, electric shock. Do not touch the device after it is powered on. Otherwise, an electric shock may occur.
	Danger. Due to possible risks, do not touch the device after it is powered on.
	Observe enclosed documentation.
	The device cannot be disposed together with the household waste.
	Do not operate the system until it is isolated from mains and battery.
	Danger of high voltage. Do not touch live parts for 10 minutes after disconnection from the power sources.
	The battery system must be disposed of at a proper facility for environmentally safe recycling.
	The battery module may explode. The rechargeable battery can become hot during operation. Avoid touch during operation.
	Keep the device away from children.
	Keep the device from open flames or ignition sources.

## 3 Transportation and Storage

### 3.1 Transportation Requirements

#### Danger!

•Please be careful to avoid physical collisions during transportation. Do not place the equipment upside down, be exposed to water, etc., which may result in equipment damage, or even a fire or an explosion.

#### Notice!

•Please strictly comply with the transportation requirements of the warning signs on the packaging and equipment.

•The tilt angle of the cabinet should be  $\leq 10^\circ$  while transporting and moving it.

•To reduce product damage caused by shocking, tilting or impacting during transportation, it is recommended to consider sea or road (with better conditions) transport instead of rail and air transports.

•Relevant qualifications for the transport of dangerous goods must be obtained by the forwarding agent engaged in such businesses, and they must strictly abide by the local regulations for the transport of dangerous goods. Please check the battery before transportation. If a battery leaks, smells, or is damaged, do refuse to transport it.

#### 3.1.1 Forklift

Please confirm that the forklift's load-bearing capacity shall be  $\geq 3$  t before using it.

The forklift should meet the following requirements: length of fork blade  $> 1.2$  m, width of fork blade between 60 cm and 160 cm, and thickness of fork blade between 25 cm and 70 cm.

Before moving the device, please pay attention to the center of gravity position of the load, and fully secure the load on the forklift by securing measures, such as ropes or bindings. In addition, please designate a person to supervise for safety concerns during transportation.

Before unpacking, please accurately insert the fork blade into the fork holes on the carton when moving the device.

The equipment can only be transported by forklift before unpacking.

#### 3.1.2 Hoisting

A hoist operator with good operational skills and safety awareness, who must be trained and certified, shall be operated according to the local laws and regulations.

After unpacking, the following requirements must be met when working with cranes and lifting ropes: crane hoisting capacity  $\geq 5$  t, hoisting operating radius  $\geq 2$  m.

Before hoisting, please check:

- » Lifting tools are complete, tested and fully secured.
- » The device door is closed and locked to avoid accidental opening.
- » The lifting rope's quality must meet standards, and it shall be fully secured, to avoid falling and fraying.

Do not hoist outdoors in rain, snow, wind and other bad weather.

It is recommended to hoist devices in sequence and to ensure that the hoist moves in the same direction.

## 3.2 Storage Requirements

### 3.2.1 Cabinet Storage

For long-term storage, do not remove the original packaging and check the packaging regularly.

Please strictly comply with the storage requirements of the warning signs and other information on the packaging to avoid device damage.

Storage temperature:  $-20^{\circ}\text{C} \sim +60^{\circ}\text{C}$ .

Relative humidity for device storage: 5% ~ 95%.

#### Notice!

•Since the batteries have been installed in the cabinet in the factory, the storage requirements for the battery must also be abided by when storing the cabinet.

### 3.2.2 Battery Storage

#### Danger!

•The battery must be stored indoors, which the environment should meet the following requirements:

1. Avoiding direct sunlight and keeping out of rain.
2. Dry and well-ventilated.
3. Keeping away from heat and fire sources.
4. Keeping away from radiation.
5. Keeping away from chemicals.
6. Keeping away from dust and metal conductive dust.
7. Being equipped with fire facilities.

•Batteries must be stored in accordance with the requirements of the warning signs and other information on the packaging.

•Do not store with any other electronic equipment, chemicals, or other items that may cause interference or danger.

•Please pay attention to the height when stacking batteries to avoid deforming or damaging the battery at the bottom.

**Notice!**

•Do not store the batteries for a long time. If long periods of storage are unavoidable, please recharge it periodically to avoid battery damage.

Regarding with the storage information, see the following table:

Table 3-1 Storage information

Storage temperature range	Storage time
50°C to 60°C	3 months
30°C to 50°C	6 months
-20°C to 30°C	12 months

Relative humidity for device storage: 5% ~ 95%.

If the battery has been stored for more than 1 year, it must be checked and tested by professionals before use.

•

## 4 Preparation before Installation

### 4.1 Installation Site Selection

The installation site is critical to the safety, service life, and performance of the device, and it should be convenient for electrical connections, operation, and maintenance. Therefore, the installation site should be selected according to the *NFPA 855 Standard for the Installation of Stationary Energy Storage Systems* and the local laws and regulations.

Type of foundation material: 1. Non-combustible materials such as solid bricks or concrete; 2. Steel.

The bottom of the foundation pit must be strengthened and filled. The surface of the foundation shall be solid, flat and level (horizontal error  $\leq 3\text{mm}$ , tilt angle  $\leq 5^\circ$ ).

The foundation's bearing capacity shall exceed 5 t.

A qualified drainage facility, of which the drainage capacity meets the requirements of the heaviest rain records in local history, shall be established according to the local geological conditions and municipal drainage standards.

Reserve a trench or cable entry hole during the design phase.

### 4.2 Tools Requirement

The tools used include but are not limited to the recommended tools below. Please use other auxiliary tools according to the site requirements. Please note that the tools used must comply with local regulations.

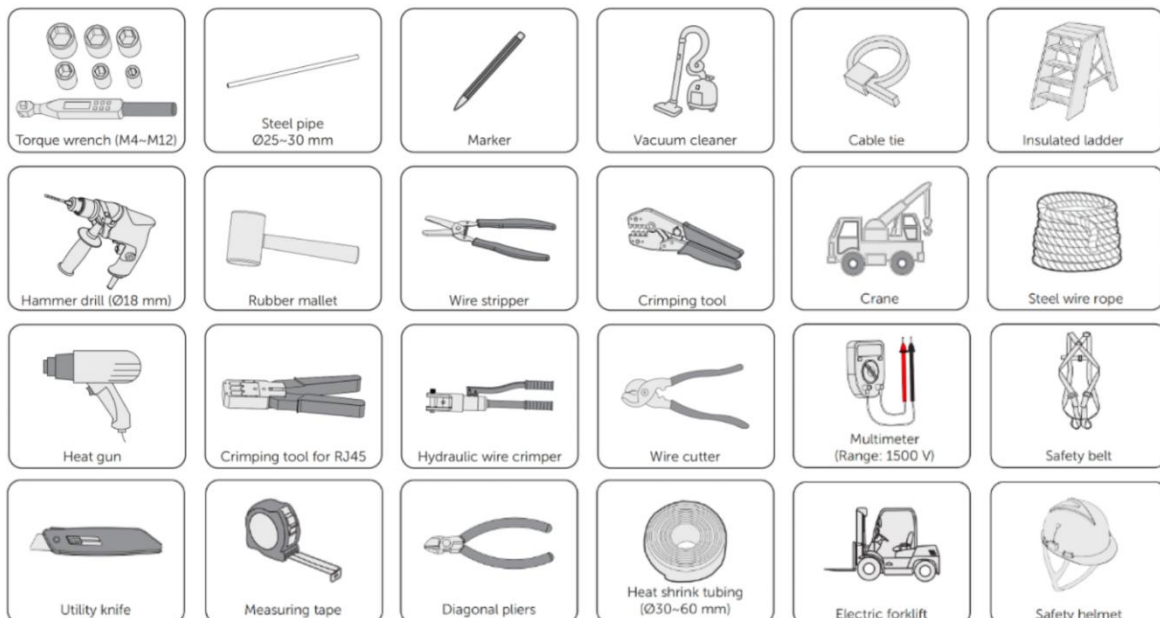



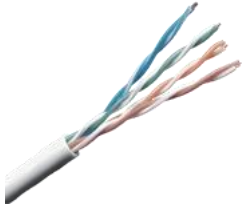

Figure 4-1 Tools List

### 4.3 Additionally Required Materials

The following is a recommended list of equipment required for installation of the system.

Table 4-1 Additionally required materials

Required Material	Picture	Type
Grounding plate		Galvanized iron plate Width: 40 mm Depth: 4mm
Grid wire		Five-core copper cable YJV 50 mm <sup>2</sup> * 4 + 25 mm <sup>2</sup> * 1
Additional PE wire		Conventional yellow and green wire BVR 50 mm <sup>2</sup>
Ethernet cable		Category-6

## 5 Installation

### 5.1 General

Only a qualified electrical engineer can operate related electrical connection. Please comply with the requirements given in "Safety Instructions" in this manual and we shall not be liable for casualties or property loss caused by neglect of safety instructions.

#### Danger!

- Do not touch the live parts!
- Ensure both AC and DC sides are not energized before installation. All electrical connections must be operated under de-energized condition.
- Check the polarity of all input cables to ensure that each input polarity is correct before wiring.
- Do not place the equipment on surfaces that are flammable.

#### Warning!

- The ingress of sand and moisture may damage the electrical equipment inside the ESS cabinet or affect the performance of the equipment!
- During sandstorm seasons or when the relative environmental humidity exceeds 95%, electrical connection work should be avoided.
- Wait until there are no sandstorms and the weather is clear and dry before starting any connection work.
- Avoid pulling or tugging on cables or wires forcefully to prevent damage to their insulation performance during electrical installation.

#### Caution!

- All cables and wires should be ensured to have a certain amount of bending space.
- Necessary auxiliary measures should be taken to reduce the stress on cables or wires.
- After completing each step of the wiring operation, careful inspection is required to ensure correct and secure connections.
- All electrical connections must be strictly in accordance with the wiring diagram.

## 5.2 Clearance Requirement

The minimum space to be reserved around the cabinet must meet the following standards.

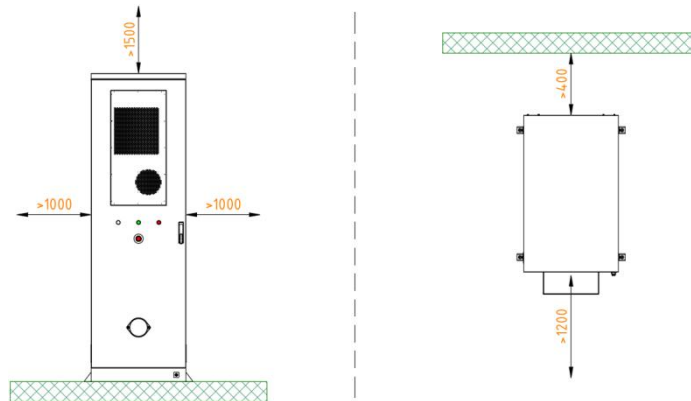

Figure 5-1 Single cabinet

## 5.3 Mechanical Installation

After determining the installation site, please take out the required underground cables.

### Warning!

- Avoid installing, operating and maintaining the device or cables outdoors under severe weather conditions such as lightning, rain or snow.
- The device must be installed by professionals in accordance with local regulations and standards.
- Before drilling, please check and ensure that the area is free of pipes, light switches, sockets, and wires, and safe to drill into.
- Please wear PPE, and take steps to cover the device to prevent debris from entering it while drilling holes.
- After drilling, clean up the site in time.

### Notice!

- There are two ways to move a cabinet: using a crane or a forklift.

### 5.3.1 Crane Handling

#### Notice!

- Temporary warning signs or fences should be set up in the hoisting area, and only the qualified persons can access it.
- Never stand and walk under or near the device being lifted or lowered.
- For safety reasons, avoid long-distance hoisting operations.
- Please be careful when hoisting and placing the device, and do not remove the ropes before it is seated on the foundation. Please make sure that the boom lift moves level and the cabinet's tile angle is  $\leq 5^\circ$  during hoisting.

- The angle in both the diagonal ropes shall be  $\leq 60^\circ$ .
- Do not lift the next one before the previous cabinet has been installed on the foundation.

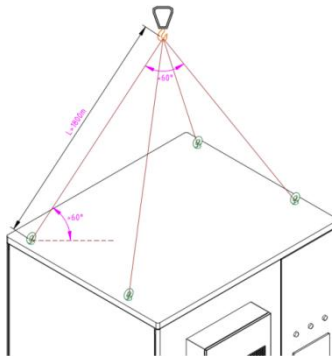

Figure 5-3 Proper way of hoisting

### 5.3.2 Fork Hole Position

#### Notice!

- When using a forklift to move the cabinet, please secure it according to the actual situation to ensure that the cabinet does not pose a risk of tipping over.

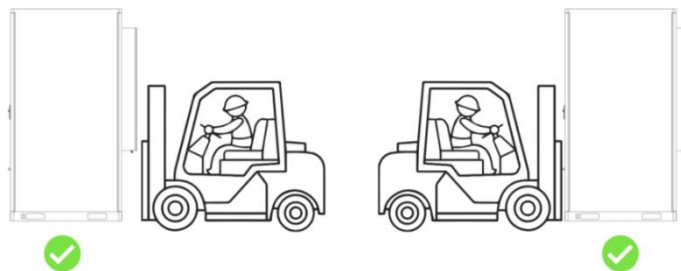

Figure 5-5 Right positions

## 5.4 Electrical Connection

#### Notice!

- Before wiring, operators are required to learn which parts need to be conducted wiring.

### 5.4.1 Grounding Connection

The equipment supports grounding plate connection and PE connection.

#### Notice!

- There are two GND ports on the cabinet. Either of them can be connected.
- The grounding plate or the PE wire, and bolts are prepared by the user self.
- Cross-section of the grounding plate recommends 40x4mm.
- Cross-section of the PE wire recommends  $\varnothing 50\text{mm}^2$ .

Insert and tighten M10 screw to secure grounding plate or PE wire (torque:  $25\pm 2\text{ N}\cdot\text{m}$ ).

## 6 System Commissioning

### 6.1 Check before Power On

Ensure that all the cables connecting to the cabinet battery and distribution box (grid side) are wired and securely fastened.

## 7 Troubleshooting and Maintenance

### 7.1 Troubleshooting

This section lists the possible problems with the equipment, and provides information and procedures for identifying and resolving them. In case of any errors, check for the warnings or error messages on the system control panel or App, and then refer to the suggestions below.

For further assistance, contact our Customer Service. Please provide the model and SN of the cabinet, and be prepared to describe the system installation details.

Table 7-1 Troubleshooting list

Fault	Description and Diagnosis
UCellH_3	Single Cell Overvoltage Category Level 3 •Do not power on, and the charging current is limited to 0 A. If the relay does not receive a power-off instruction from the PCS, it will be turned off forcefully after 3 seconds.
UCellL_3	Single Cell Undervoltage Category Level 3 •Do not power on, and the charging current is limited to 0 A. If the relay does not receive a power-off instruction from the PCS, it will be turned off forcefully after 3 seconds.
UCellDiff	Voltage difference fault •Contact us for help.
HVBOver_3	Overvoltage category Level 3 of total voltage •The charging current is limited to 0 A. If the relay does not receive a power-off instruction from the PCS, it will be turned off forcefully after 3 seconds.
HVBLow_3	Undervoltage category Level 3 of total voltage •The charging current is limited to 0 A. If the relay does not receive a power-off instruction from the PCS, it will be turned off forcefully after 1 second.
PosRlyAdh	Sticking contacts of main positive relay •The charging current is limited to 0 A. If the relay does not receive a power-off instruction from the PCS, it will be turned off forcefully after 1 second.
NegRlyAdh	Sticking contacts of main negative relay •Restart the device
TempHigh	Overtemperature fault •The charging current is limited to 0 A. If the relay does not receive a power-off

	instruction from the PCS, it will be turned off forcefully after 1 second.
TempLow	Low-temperature fault <ul style="list-style-type: none"> <li>•The charging current is limited to 0 A. If the relay does not receive a power-off instruction from the PCS, it will be turned off forcefully after 1 second.</li> </ul>
DsgOver_3	Discharge overcurrent fault Level 3 <ul style="list-style-type: none"> <li>•The charging current is limited to 0 A. If the relay does not receive a power-off instruction from the PCS, it will be turned off forcefully after 3 seconds.</li> </ul>
ChgOver_3	Charge overcurrent fault Level 3 <ul style="list-style-type: none"> <li>•The charging current is limited to 0 A. If the relay does not receive a power-off instruction from the PCS, it will be turned off forcefully after 3 seconds.</li> </ul>
COMFault	Communication fault <ul style="list-style-type: none"> <li>•Do not power on, and the charging current is limited to 0 A. If the relay does not receive a power-off instruction from the PCS, it will be turned off forcefully after 1 second.</li> </ul>
InsFlt	Insulation fault <ul style="list-style-type: none"> <li>•The charging current is limited to 0 A. If the relay does not receive a power-off instruction from the PCS, it will be turned off forcefully after 1 second.</li> </ul>
SOCLowFlt	Low SOC <ul style="list-style-type: none"> <li>•Check if the device is running out of power.</li> </ul>
DCSwitch	DC switch fault <ul style="list-style-type: none"> <li>•Contact us for help.</li> </ul>

## 7.2 Maintenance

Regular maintenance is required for the device. The table below lists the operational maintenance for expressing the optimum device performance.

More frequent maintenance service is needed in the worse work environment. Please make records of the maintenance.

<b>Warning!</b>
<ul style="list-style-type: none"> <li>•Only qualified person can perform the maintenance for the device.</li> <li>•Only use the spare parts and accessories for maintenance.</li> </ul>

Table 7-2 Maintenance routine list

Check Item	Description	Interval Time
The operating status and environment of the system	<ul style="list-style-type: none"> <li>•Check whether there is any damage to the distributed energy system, and the equipment is deformed.</li> <li>•Check whether there are any abnormal noise in the running system.</li> <li>•Check whether the parameter is correct shown in the screen.</li> <li>•Check whether there is any damage to the main components.</li> <li>•Check whether the temperature of the equipment shell is normal. Meanwhile, it is suggested to use a thermal imager or any other monitoring systems to identify signs of heat.</li> <li>•Check whether the surrounding is at normal humidity level, and there is any damage to the dust and air filters.               <ul style="list-style-type: none"> <li>➢ Must ensure that the air intake is well ventilated. Otherwise, the battery pack failure will be caused due to overheating.</li> <li>➢ Please gently open the door to prevent raising dust from the filter cotton. Otherwise, the smoke detector will alarm and give a command to the fire sprinkler to spray gas.</li> </ul> </li> </ul>	Every 6 months
System cleaning	<ul style="list-style-type: none"> <li>•Check whether the circuit boards and components are clean.</li> <li>•If necessary, clean the modules by air compressor.               <ul style="list-style-type: none"> <li>➢ The system must be shut down before cleaning.</li> <li>➢ The maintenance period shall be shortened if the cabinet is installed in heavily polluted environments.</li> </ul> </li> </ul>	Every 6 months
Electrical connection	<ul style="list-style-type: none"> <li>•Check whether the power cables are fastened securely. If not, please tighten them again according to the torque written in the document.</li> <li>•Check there is any damage to the cables, especially the cable jacket connecting with the metal parts.</li> <li>•Check whether the electrical insulation tape is in good condition and no peeling.</li> </ul>	The check shall be scheduled within one month after the first commissioning, and then can be scheduled every 6 months
Terminal and block	<ul style="list-style-type: none"> <li>•Check whether the screws are fastened securely. If not, please tighten them again according to the torque written in</li> </ul>	The check shall be scheduled within one

connection	<p>the document.</p> <ul style="list-style-type: none"> <li>•Check whether there is any fading to the screws and copper bars.</li> <li>•Check whether the wiring arrangement is reasonable.</li> <li>•Check whether the loop terminals are in good condition, and the temperature of the screws is normal.</li> </ul>	month after the first commissioning, and then can be scheduled every 6 months
Relay maintenance	<ul style="list-style-type: none"> <li>•Do a routine inspection for the corrosion of all metal components.</li> <li>•Do an annual inspection for the connectors to make sure that the equipment is in good running condition.</li> <li>•Check whether the parameter is correct.</li> </ul>	Every 6 months
Aerosol inspection	<ul style="list-style-type: none"> <li>•Check whether the aerosol is in good condition, and wiring are fastened securely.</li> </ul>	Every 6 months
Safety function	<ul style="list-style-type: none"> <li>•Check whether the emergency stop button is in good working condition.</li> <li>•Check the stopping signal and communication by simulating the shutdown operation.</li> <li>•Check whether there are any damages to warning signs and other labels pasted on the equipment. If so, please replace them in time.</li> </ul>	Every 6 months

Table 7-3 Maintenance of Pack

Circumstance	Measure
If the ambient temperature for storage is between 30°C and 50°C	Recharge the battery packs at least once every 6 months
If the ambient temperature for storage is between -20°C and 30°C	Recharge the battery packs at least once every 12 months.
In the first installation	The interval among manufacture dates of battery packs shall not be exceed 3 months.
If a battery pack is replaced or added for capacity expansion	Each battery's SOC should be consistent. The max. SOC difference should be $\pm 5\%$ .
If users want to increase their battery system capacity	Ensure that the SOC of the existing system capacity is about 40%. The manufacture date of the new battery pack shall not exceed 6 months. If the manufacture date of the new one exceeds 6 months, please charge it to around 40%.
<b>Warning!</b>	
•Only qualified person can perform the maintenance for the device.	

## 8 Technical Data

Model		SKTESS72	SKTESS86	SKTESS100
Battery	Battery Type	LiFePO4		
	Battery Capacity	280Ah		
	Pack Configuration	1P80S	1P96S	1P112S
	Nominal Energy	71.68kWh	86.016kWh	100.352kWh
	Nominal Voltage	256V	307.2V	358.4V
	Operating Voltage Range	224~288V	268.8~345.6V	313.6~403.2V
	Max.Charge Current	140A		
	Max.Discharge Current	150A		
	Charge/Discharge Rate	0.5P		
	Ingress Protection	IP54		
	Cycle Life	≥6000(@25°C±2°C,0.5P/0.5P,70%EOL)		
	Charge Operating Temperature	0°C~45°C		
	Discharge Operating Temperature	-20°C~50°C		
	Operating Temperature Range	-20°C~50°C		
	Storage temperature	0°C~35°C		
	Noise	< 70db		
	Relative Humidity	5~95 % ( non-condensing )		
	Communication	CAN/RS485		
	Cooling	Air Cooling		
	Dimension	851.5(±5)×1325(±5)×2280(±5)mm		
Weight	1050(±10)kg	1150(±10)kg	1250(±10)kg	
Max. Parallel	5			

## A Crimping DT or OT Terminals

### A.1 Terminal Requirements

For different types of cables, select proper terminals and additional components for connection.

Caution!
<ul style="list-style-type: none"> <li>•Do not connect the aluminum wiring terminal directly to the terminal block or copper bar in case of electrochemical corrosion, which might affect the reliability of cable connection.</li> <li>•While using an aluminum wiring terminal, copper washer, and aluminum washer, pay special attention to the position of the two washers. The copper washer shall contact the terminal block, and the aluminum washer shall contact the aluminum wiring terminal.</li> </ul>

Notice!
<ul style="list-style-type: none"> <li>•The copper-to-aluminum wiring terminal used in scenario 3, and aluminum wiring terminal, copper washer, and aluminum washer used in scenario 4 must comply with the requirements in IEC61238-1.</li> </ul>

Table A-1 Terminal requirements for different types of cables

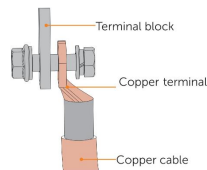
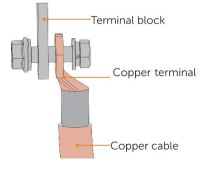
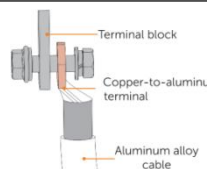
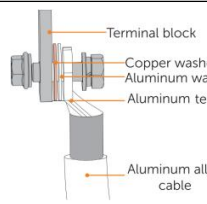
Scenario	Cable Type	Terminal Type	Figure
1	Copper cable	Copper terminal	 <p>Labels: Terminal block, Copper terminal, Copper cable</p>
2	Copper-clad aluminum cable	Copper terminal	 <p>Labels: Terminal block, Copper terminal, Copper cable</p>
3	Aluminum alloy cable	Copper-to-aluminum terminal	 <p>Labels: Terminal block, Copper-to-aluminum terminal, Aluminum alloy cable</p>
4	Aluminum alloy cable	Aluminum terminal	 <p>Labels: Terminal block, Copper washer, Aluminum washer, Aluminum terminal, Aluminum alloy cable</p>

## A.2 Crimping an OT or DT Terminal

### Notice!

- Avoid scratching the core wire when stripping a cable.
- The cavity formed after the conductor crimp strip of the OT or DT terminal has been crimped must wrap around the core wire completely. The core wire must make close contact with the OT or DT terminal.
- Wrap the wire crimping area with heat shrink tubing or insulation tape. The heat shrink tubing is used as an example.
- Use a heat gun carefully to avoid heat damage to the equipment.

Figure A-1 Crimping an OT terminal

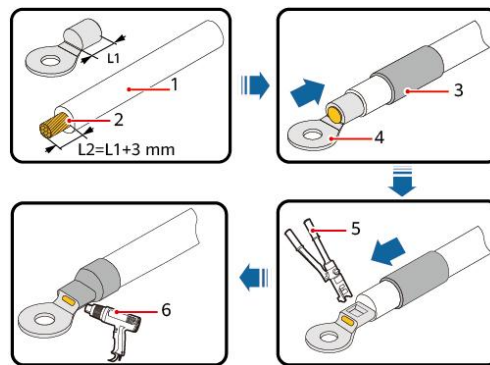

- 1) Cable                      2) Core wire                      3) Heating shrink tubing  
4) OT terminal              5) Hydraulic pliers              6) Heat gun

Figure A-2 Crimping a DT terminal

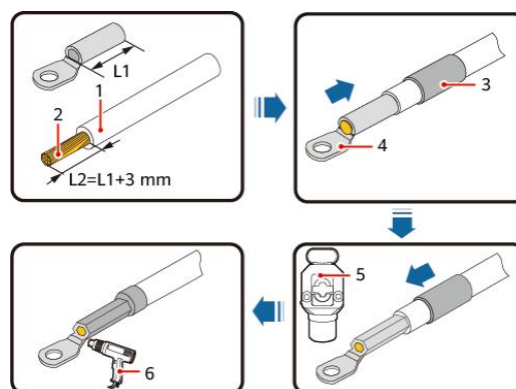

- 1) Cable                      2) Core wire                      3) Heating shrink tubing  
4) DT terminal              5) Hydraulic pliers              6) Heat gun

## B How to Repaint the Cabinet

The equipment appearance should be intact. If paint has flaked off, repair paint damage immediately.

### Warning!

•If the cabinet is installed outdoors without shield, do not repaint it in rainy, snowy, windy, or stormy days.

Check the paint damage on the surface of the cabinet, with details below:

For light scratches or small areas of stubborn stains, please see '[B.1 Light Scratches and Small Areas of Stubborn Stains](#)' to treat them.

If the deep scratches or large areas of stubborn stains can be treated by users, please refer to '[B.2 Deep Scratches and Large Areas of Stubborn Stains](#)'.

If the damaged area is too large and cannot be treated, please contact the after-sale personnel for assistance.

### Notice!

- Use paint of RAL 7035 color.
- For light scratches and small areas of stubborn stains, spray paint and hairbrush are recommended.
- For deep scratches or large areas of stubborn stains, oil paint and paint sprayer are recommended.

### B.1 Light Scratches and Small Areas of Stubborn Stains

This solution applies to light scratches without reaching the steel substrate and stubborn stains on the surface.

Prepare tools and enough materials according to actual conditions.

Table B-1 Tools and materials

No.	Tool/Material
1	Spray/oil paint
2	Fine sandpaper
3	Anhydrous ethanol
4	Cotton cloth
5	Hairbrush

## Repainting Procedure

**Step 1:** Gently sand the scratched area with a fine sandpaper to remove rust and stains on the surface.

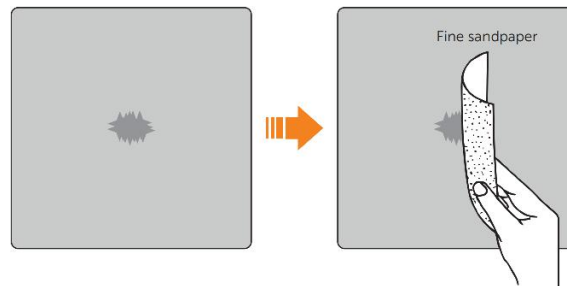

Figure B-1 Sanding the scratched area

**Step 2:** Moisten a cotton cloth with anhydrous ethanol, wipe the scratched area with it to remove dust and dirt, and then use a dry cotton cloth to wipe the area dry.

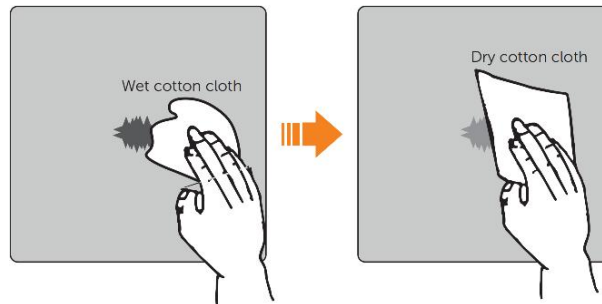

Figure B-2 Cleaning the scratched area

**Step 3:** Use hairbrush or spray paint to apply paint to the surface of the scratched area until it is fully and evenly covered.

### Notice!

- While applying paint, make sure the newly applied paint is thin and even, so that the scratched area can appear consistent and smooth on the surface.
- If there is color difference between the scratched area and the surroundings, cover the surrounding area with tape or paper in case of color contamination.

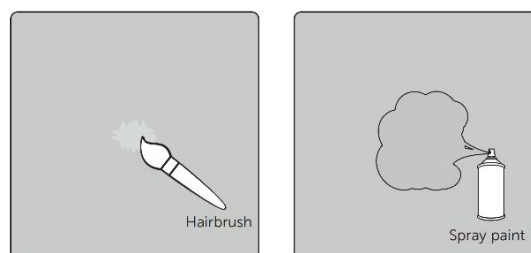

Figure B-3 Applying paint

**Step 4:** After completing applying the paint, wait for around 30 minutes for the paint to get dry, and then check whether the repaired area meets the requirements.

Notice!	
<ul style="list-style-type: none"> <li>•The color of the repaired area shall be consistent with the surrounding area.</li> <li>•For spray painting, we recommend painting for at least 3 times before pausing to check the effect, and then repeat spray painting and observing until it meets the requirements.</li> </ul>	

## B.2 Deep Scratches and Large Areas of Stubborn Stains

This solution applies to deep scratches where the primer has been damaged and reach the steel substrate.

Prepare tools and enough materials according to actual conditions.

Table B-2 Tools and materials

No.	Tool/Material
1	Spray/oil paint
2	Zinc-rich primer
3	Fine sandpaper
4	Anhydrous ethanol
5	Cotton cloth
6	Paint sprayer

### Repainting Procedure

**Step 1:** Gently sand the scratched area with a fine sandpaper to remove rust and stains on the surface.

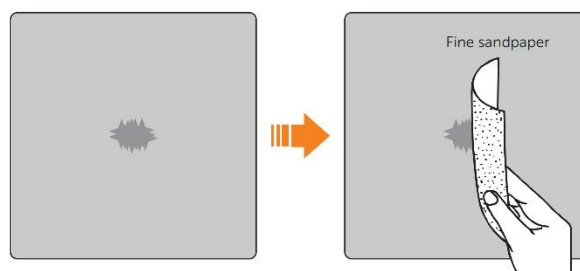

Figure B-4 Sanding the scratched area

**Step 2:** Moisten a cotton cloth with anhydrous ethanol, wipe the scratched area with it to remove dust and dirt, and then use a dry cotton cloth to wipe the area dry.

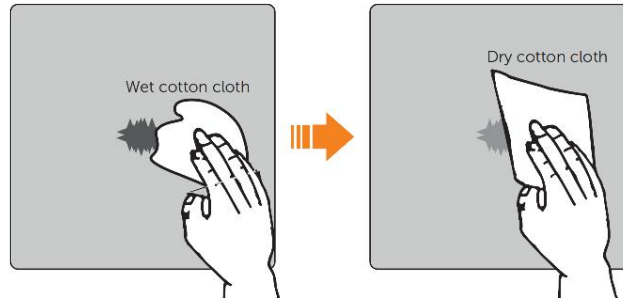

Figure B-5 Cleaning the scratched area

**Step 3:** Use a paint spray to apply the zinc-rich primer to the scratched area.

**Notice!**

- If the steel substrate is visible on the scratched area, the zinc-rich primer must be applied first to entirely cover the substrate.
- Wait for the primer to get dry before applying the topcoat to the scratched area.

**Step 4:** Use a paint spray to apply paint to the surface of the scratched area until it is fully and evenly covered.

**Notice!**

- While applying paint, make sure the newly applied paint is thin and even, so that the scratched can appear consistent and smooth on the surface.
- If there is color different between the scratched area and the surroundings, cover the surrounding area with tape or paper in case of color contamination.

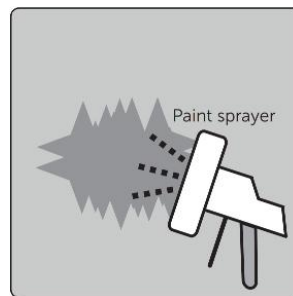

Figure B-6 Applying paint

**Step 5:** After completing applying the paint, wait for around 30 minutes for the paint to get dry, and then check whether the repaired area meets the requirements.

**Notice!**

- The color of the repaired area shall be consistent with the surrounding area.
- For spray painting, we recommend painting for at least 3 times before pausing to check the effect, and then repeat spray painting and observing until it meets the requirements.